

**DESIGN
LUCE**

K25



DISEGNIAMO CON LA LUCE



CONFIGURAZIONI / CONFIGURATIONS

SISTEMA SOSPENSIONE+ATTACCO A SUPERFICIE
SUSPENSION SYSTEM + SURFACE MOUNT

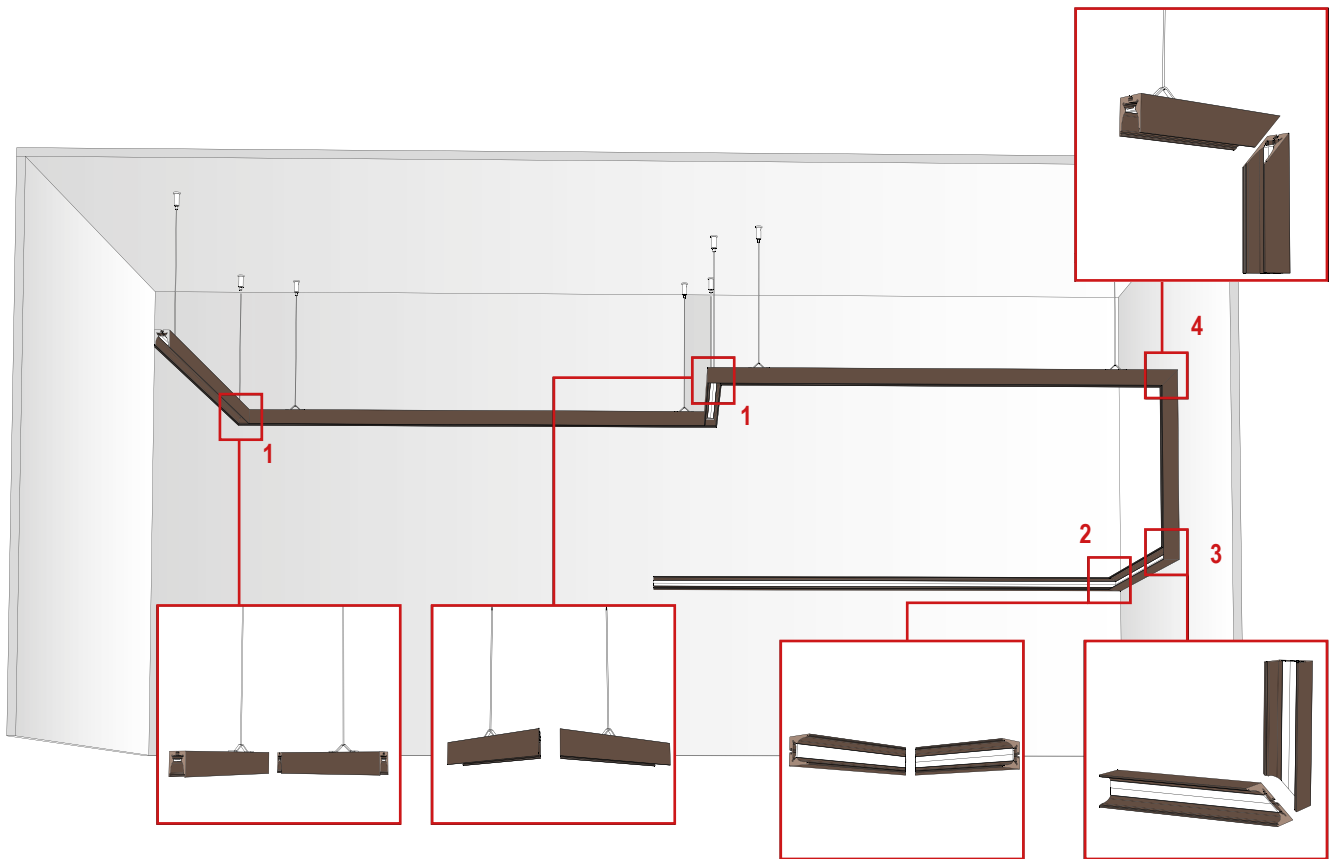

1. SOSPENSIONE - ANGOLO 90° ORIZZONTALE
1. SUSPENSION - HORIZONTAL 90° ANGLE

ACCESSORI E LAVORAZIONI
ACCESSORIES AND PROCESSING

KIT SOSPENSIONE / SUSPENSION KIT
GIUNTO MECCANICO / MECHANICAL JOINT
TAGLIO ANGOLARE / CORNER CUT

2. SOFFITTO - ANGOLO 90° ORIZZONTALE
2. CEILING - HORIZONTAL 90° ANGLE

ACCESSORI E LAVORAZIONI
ACCESSORIES AND PROCESSING

STAFFA FISSAGGIO / FIXING BRACKET
GIUNTO MECCANICO / MECHANICAL JOINT
TAGLIO ANGOLARE / CORNER CUT

3. PARETE - ANGOLO 90° VERTICALE
3. WALL - VERTICAL 90° CORNER

ACCESSORI E LAVORAZIONI
ACCESSORIES AND PROCESSING

STAFFA FISSAGGIO / FIXING BRACKET
GIUNTO MECCANICO / MECHANICAL JOINT
TAGLIO ANGOLARE / CORNER CUT

4. SOSPENSIONE+PARETE ANGOLO 90° VERTICALE
4. SUSPENSION + WALL 90° VERTICAL CORNER

ACCESSORI E LAVORAZIONI
ACCESSORIES AND PROCESSING

STAFFA FISSAGGIO / FIXING BRACKET
GIUNTO MECCANICO / MECHANICAL JOINT
KIT SOSPENSIONE / SUSPENSION KIT
TAGLIO ANGOLARE / CORNER CUT

INSTALLAZIONE CON CLIP IN POLICARBONATO SU SUPERFICIE ORIZZONTALE
INSTALLATION WITH POLYCARBONATE CLIP ON HORIZONTAL SURFACE

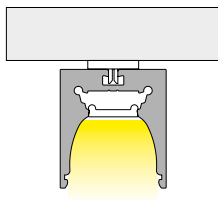

INSTALLAZIONE A SOSPENSIONE
SUSPENSION

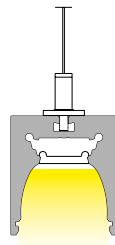

INSTALLAZIONE CON CLIP IN POLICARBONATO SU SUPERFICIE VERTICALE
INSTALLATION WITH POLYCARBONATE CLIP ON A VERTICAL SURFACE

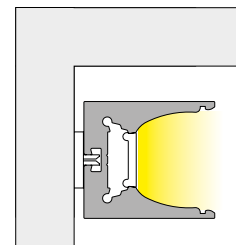

CONFIGURAZIONI / CONFIGURATIONS

APPLIQUE E FISSAGGIO SU SUPPORTO MAGNETICO APPLIQUE AND FIXING ON MAGNETIC SUPPORT

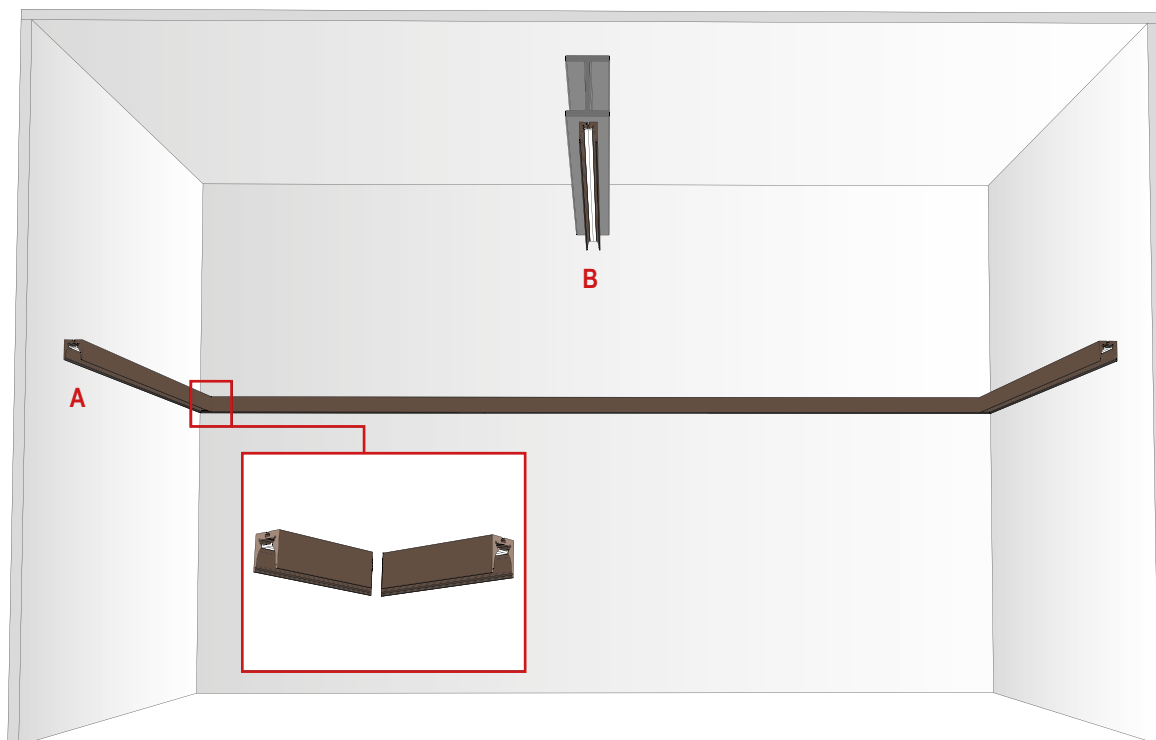

1. APPLIQUE - ANGOLO 90° ORIZZONTALE
1. WALL LAMP - HORIZONTAL 90 ° CORNER

ACCESSORI E LAVORAZIONI
ACCESSORIES AND PROCESSING

STAFFA A PARETE / WALL BRACKET

GIUNTO MECCANICO / MECHANICAL JOINT

TAGLIO ANGOLARE / CORNER CUT

A) APPLIQUE / WALL LAMP

B) FISSAGGIO MAGNETICO / MAGNETIC FIXING

INSTALLAZIONE CON STAFFA MAGNETICA SU SUPERFICIE METALLICA ORIZZONTALE
INSTALLATION WITH MAGNET ON HORIZONTAL METAL SURFACE

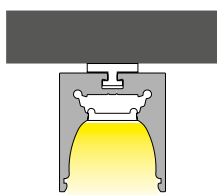

SI RACCOMANDA L'UTILIZZO DI N° 1 STAFFA MAGNETICA OGNI 25,00 cm DI PROFILO. TALE QUANTITÀ PUÒ VARIARE A SECONDA DELLA SUPERFICIE METALLICA DI INSTALLAZIONE.

WE RECOMMEND THE USE OF N° 1 MAGNETIC BRACKET EVERY 25.00 cm OF PROFILE. THIS QUANTITY MAY VARY DEPENDING ON THE METAL INSTALLATION SURFACE.

INSTALLAZIONE A PARETE
WALL INSTALLATION

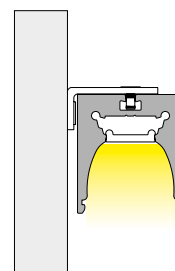

ANGOLO DIVERSO DA 90°
ANGLE DIFFERENT FROM 90 °

È POSSIBILE RICHIEDERE LA REALIZZAZIONE DI COMPOSIZIONI ANGOLARI CON ANGOLO DI AMPIEZZA DIVERSA DA 90°. OGNI RICHIESTA DEVE PervenIRE AL NOSTRO UFFICIO TECNICO CORREDATA DA PROGETTO.

IT IS POSSIBLE TO REQUEST THE CREATION OF ANGULAR COMPOSITIONS WITH AN ANGLE OF DIFFERENT 90 °. EVERY REQUEST MUST COME TO OUR TECHNICAL OFFICE WITH PROJECT.

K25



DATI TECNICI TECHNICAL DATA

	1 cm - 20W/m	1 cm - 24W/m
Nominal LED Flux:	2200 lm/m	2160 lm/m
Flux Tot:	1760 lm/m	1728 lm/m
Output:	110 lm/W	90 lm/W
CCT:	3000 K	3000 K
CRI:	>90	>90
Power Tot:	20.0W/m	24.0W/m - 700 LED/m
Weight:	0.30 Kg/m	0.30 Kg/m

Profilo/Profile: Alluminio/aluminum

Cover: Opale/opal

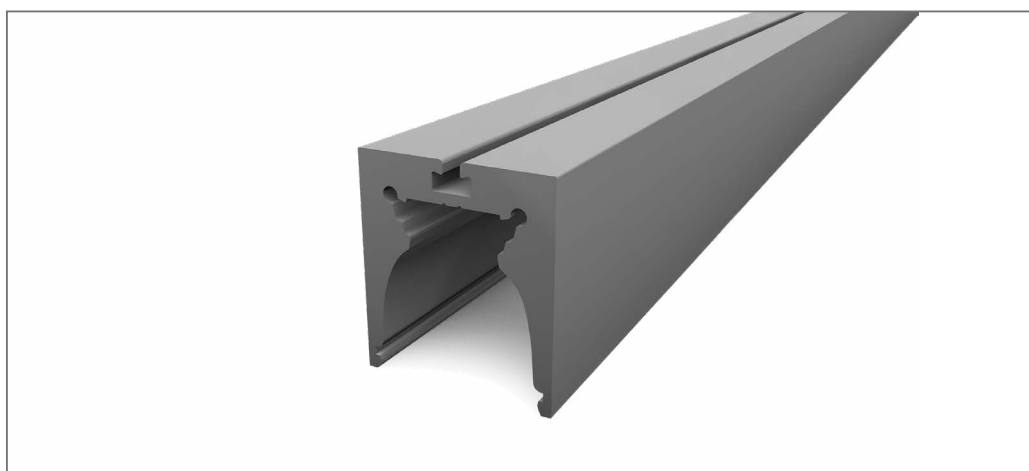
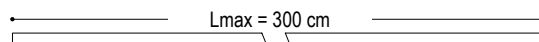
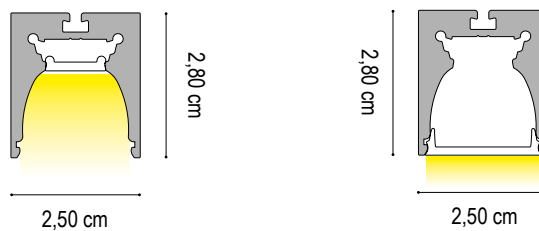

FINITURE / FINISHES



00 GRIGIO VESUVIO
00 ANTHRACITE



01 ARGILLA
01 ARGIL



02 ARGENTO OPACO
02 MATT SILVER



03 BIANCO INTONACO
03 WHITE



04 NERO CARAVAGGIO
04 BLACK



05 MOKA
01 MOCHA



08 CROMO
08 CHROME



09 ORO CALIFORNIA
09 GOLD



10 ARAMEN
10 COPPER



11 GRIGIO AVIO
11 GREY AVIO



12 ARGENTO COMETA
12 SILVER COMET



13 OTTONE VENEZIANO
13 VENETIAN BRASS



17 TERRA SENESE
17 SENESE EARTH

VERNICIATURA A POLVERE / POWDER COATING