

**DESIGN
LUCE**

ZER035

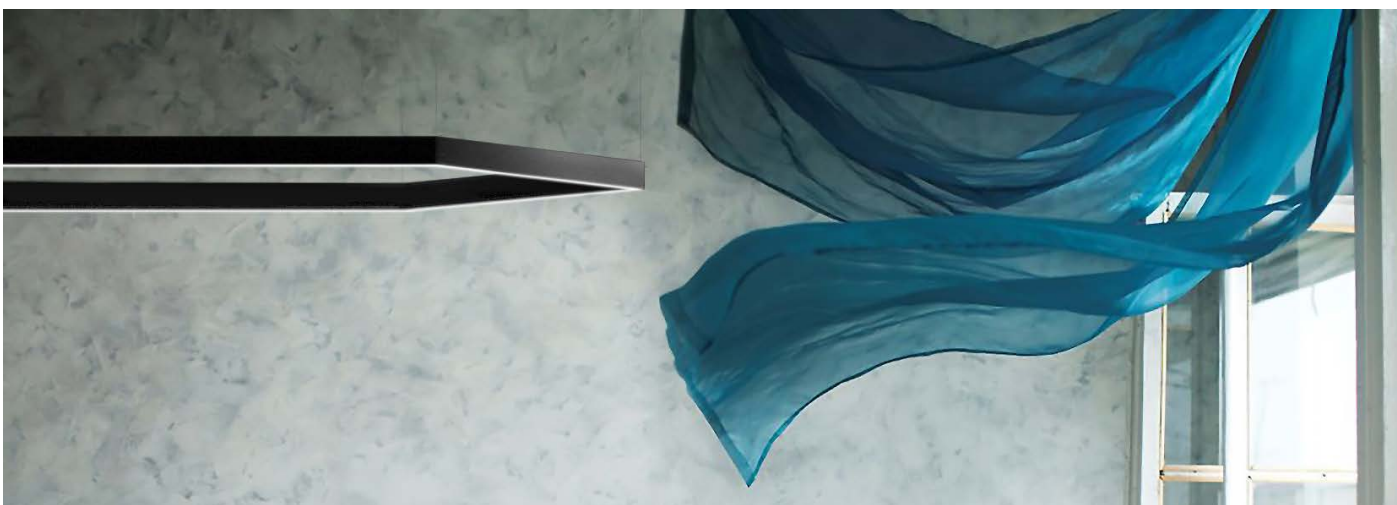

DISEGNIAMO CON LA LUCE

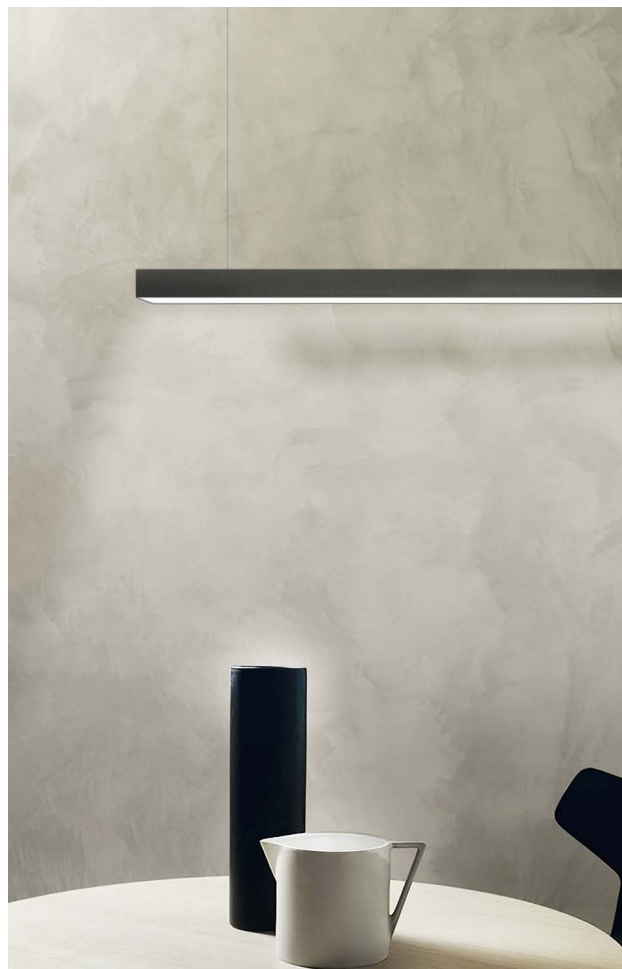

CONFIGURAZIONI / CONFIGURATIONS

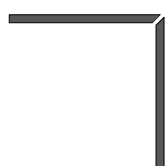

A. COMPOSIZIONE ANGOLARE A "L"
A. L-ANGLE COMPOSITION

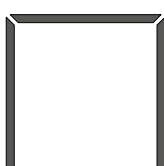

B. COMPOSIZIONE ANGOLARE A "C"
B. C-ANGLE COMPOSITION

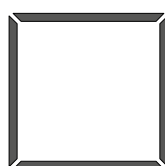

C. COMPOSIZIONE POLIGONALE (QUADRATO/RETTANGOLO)
C. POLYGONAL COMPOSITION (SQUARE / RECTANGLE)

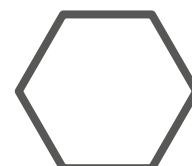

D. COMPOSIZIONE POLIGONALE (PENTAGONO/ESAGONO)
D. POLYGONAL COMPOSITION (PENTAGON / HEX)

LE COMPOSIZIONI SOPRA RIPORTATE POSSONO ESSERE REALIZZATE PER INSTALLAZIONE A SOSPENSIONE / SOFFITTO-PARETE / INCASSO. PER LE COMPOSIZIONI POLIGONALI RIVOLGERSI AL NOSTRO REPARTO TECNICO.

THE ABOVE COMPOSITIONS CAN BE MADE FOR SUSPENSION / SURFACE / BUILT-IN INSTALLATION. FOR POLYGONAL COMPOSITIONS, PLEASE CONTACT OUR TECHNICAL DEPARTMENT.

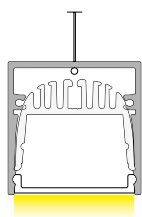

INSTALLAZIONE A SOSPENSIONE
SUSPENSION

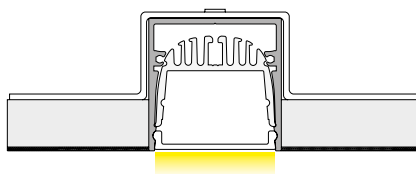

INSTALLAZIONE A INCASSO IN CARTONGESSO
RECESSED INSTALLATION IN PLASTERBOARD

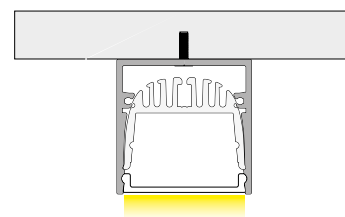

INSTALLAZIONE A SOFFITTO
CEILING INSTALLATION

ATTENZIONE!

GLI ACCESSORI PER L'INSTALLAZIONE A INCASSO SONO STATI DIMENSIONATI PER UN PANNELLO STANDARD IN CARTONGESSO DI SPESSORE 12,5 mm

WARNING!

THE BUILT-IN INSTALLATION ACCESSORIES HAVE BEEN DIMENSIONED FOR A STANDARD PLASTERBOARD PANEL OF 12.5 mm THICKNESS

CONFIGURAZIONI / CONFIGURATIONS

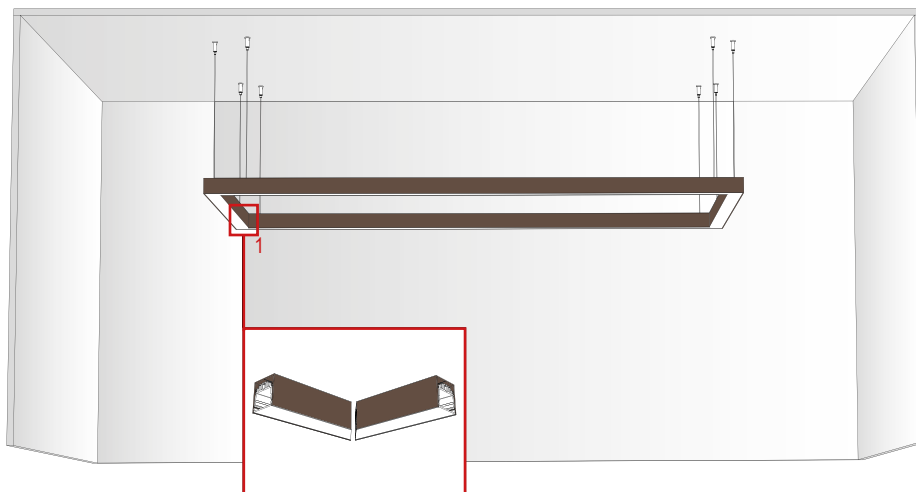

- 1. SOSPENSIONE ANGOLO 90° ORIZZONTALE**
1. SUSPENSION HORIZONTAL 90 ° ANGLE

ACCESSORI E LAVORAZIONI ACCESSORIES AND PROCESSING

GIUNTO MECCANICO / MECHANICAL JOINT
 KIT SOSPENSIONE / SUSPENSION KIT
 TAGLIO ANGOLARE / CORNER CUT

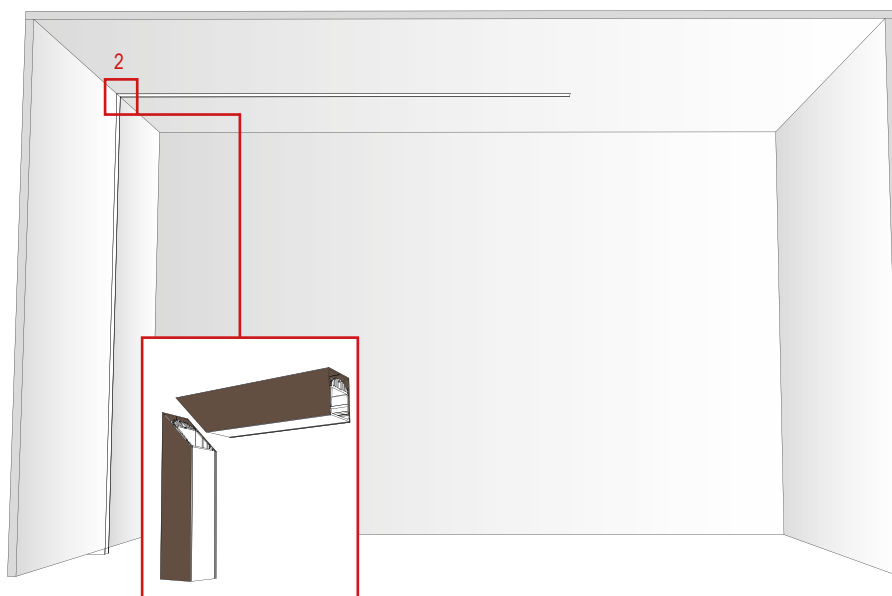

- 2. INCASSO - ANGOLO 90° VERTICALE**
2. RECESSED - VERTICAL 90 ° CORNER

ACCESSORI E LAVORAZIONI ACCESSORIES AND PROCESSING

GIUNTO MECCANICO / MECHANICAL JOINT
 TAGLIO ANGOLARE / CORNER CUT

IL FISSAGGIO A SUPERFICIE NON PREVEDE UTILIZZO DI ACCESSORI. IL PRODOTTO ZER035 SI INSTALLA A SUPERFICIE MEDIANTE UTILIZZO DI TASSELLI IDONEI AL TIPO DI MURATURA E FORANDO IL PROFILO ESTERNO IN ALLUMINIO. LA FORATURA DEL PROFILO PUÒ ESSERE RICHIESTA UTILIZZANDO IL CODICE 100F.

SURFACE MOUNTING DOES NOT INCLUDE THE USE OF ACCESSORIES. THE ZER035 PRODUCT IS INSTALLED ON THE SURFACE BY USING DOWELS SUITABLE FOR THE TYPE OF MASONRY AND DRILLING THE EXTERNAL ALUMINUM PROFILE. PROFILE DRILLING CAN BE REQUIRED USING CODE 100F.

DATI TECNICI TECHNICAL DATA

	1 cm	200 cm	300 cm	1 cm	200 cm	300 cm	1 cm	200 cm	300 cm
Nominal LED Flux:	2200 lm/m	4400 lm	6600 lm	2520 lm/m	5040 lm	7560 lm	3150 lm/m	6300 lm	9450 lm
Flux Tot:	1760 lm/m	3520 lm	5280 lm	2016 lm/m	4032 lm	6048 lm	2520 lm/m	5040 lm	7560 lm
Output:	105 lm/W	105 lm/W	105 lm/W	105 lm/W	105 lm/W	105 lm/W	105 lm/W	105 lm/W	105 lm/W
CCT:	3000 K	3000 K	3000 K	3000 K	3000 K	3000 K	3000 K	3000 K	3000 K
CRI:	>90	>90	>90	>90	>90	>90	>90	>90	>90
Power Tot:	20.0 W/m	40.0 W	60.0 W	24.0 W/m	48.0 W	72.0 W	30.0 W/m	60.0 W	90.0 W
Weight:	0.90 Kg/m	1.80 Kg	2.70 Kg	0.90 Kg/m	1.80 Kg	2.70 Kg	0.90 Kg/m	1.80 Kg	2.70 Kg

Profilo/Profile: Alluminio/aluminum

Cover: Opale/opal - Prismaticata/prismatic

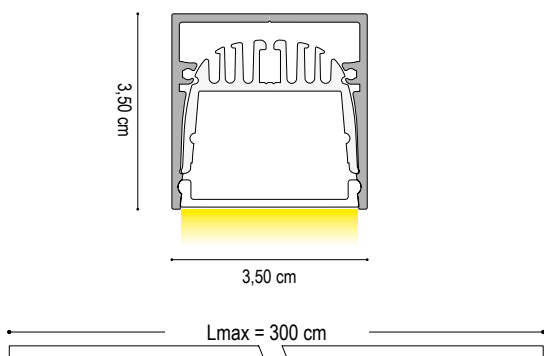

FINITURE / FINISHES



00 GRIGIO VESUVIO
00 ANTHRACITE



01 ARGILLA
01 ARGIL



02 ARGENTO OPACO
02 MATT SILVER



03 BIANCO INTONACO
03 WHITE



04 NERO CARAVAGGIO
04 BLACK



05 MOKA
01 MOCHA



08 CROMO
08 CHROME



09 ORO CALIFORNIA
09 GOLD



10 ARAMEN
10 COPPER



11 GRIGIO AVIO
11 GREY AVIO



12 ARGENTO COMETA
12 SILVER COMET



13 OTTONE VENEZIANO
13 VENETIAN BRASS



17 TERRA SESESE
17 SESESE EARTH

VERNICIATURA A POLVERE / POWDER COATING

ZER035 SQUARE



DATI TECNICI TECHNICAL DATA

	1 cm	200 cm	300 cm	1 cm	200 cm	300 cm
Nominal LED Flux:	2520 lm/m	5040 lm	7560 lm	3150 lm/m	6300 lm	9450 lm
Flux Tot:	2016 lm/m	4032 lm	6048 lm	2520 lm/m	5040 lm	7560 lm
Output:	105 lm/W	105 lm/W	105 lm/W	105 lm/W	105 lm/W	105 lm/W
CCT:	3000 K	3000 K	3000 K	3000 K	3000 K	3000 K
CRI:	>90	>90	>90	>90	>90	>90
Power Tot:	24.0 W/m	48.0 W	72.0 W	30.0 W/m	60.0 W	90.0 W
Weight:	0.90 Kg/m	1.80 Kg	2.70 Kg	0.90 Kg/m	1.80 Kg	2.70 Kg

Profilo/Profile: Alluminio/aluminum

Cover: Opale/opal

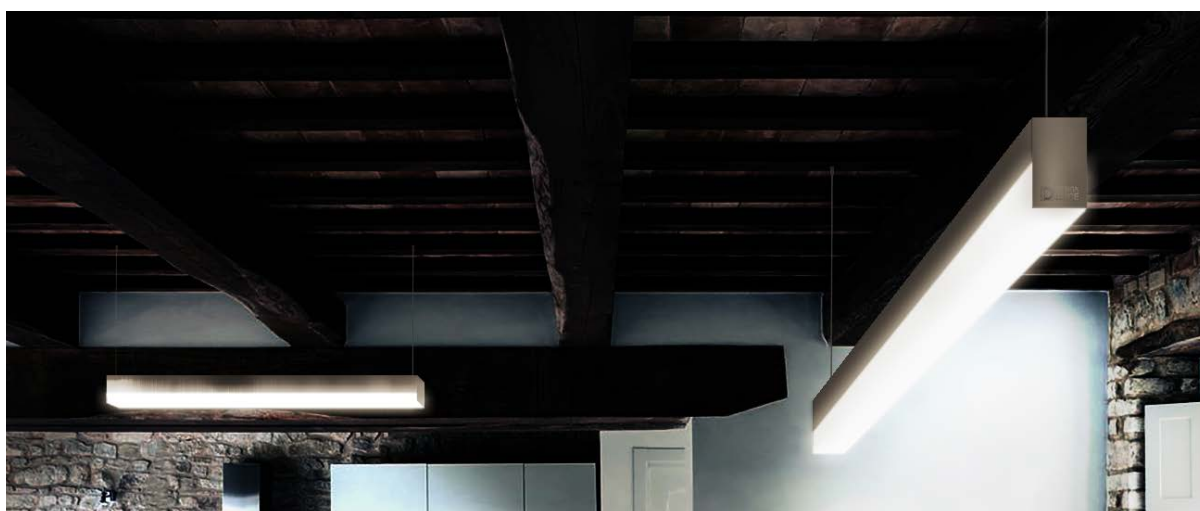
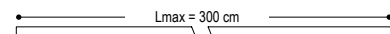
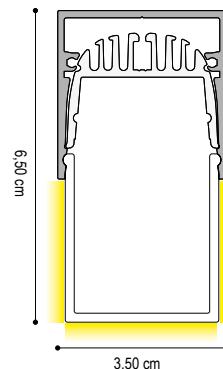

FINITURE / FINISHES



00 GRIGIO VESUVIO
00 ANTHRACITE



01 ARGILLA
01 ARGIL



02 ARGENTO OPACO
02 MATT SILVER



03 BIANCO INTONACO
03 WHITE



04 NERO CARAVAGGIO
04 BLACK



05 MOKA
01 MOCHA



08 CROMO
08 CHROME



09 ORO CALIFORNIA
09 GOLD



10 ARAMEN
10 COPPER



11 GRIGIO AVIO
11 GREY AVIO



12 ARGENTO COMETA
12 SILVER COMET



13 OTTONE VENEZIANO
13 VENETIAN BRASS



17 TERRA SENESE
17 SENESE EARTH

VERNICIATURA A POLVERE / POWDER COATING