



Design Luce s.r.l. - Via Bruno Storti 9/11
50019 - Sesto Fiorentino (Firenze)

LED 24V---
Max 24 W/m - XXXX° K RG1
EEC=A++ IP20 ta<25°C



Istruzioni GENERALI di MONTAGGIO

- Togliere la corrente dalla rete. Montare l'apparecchio seguendo le istruzioni sul retro di questo foglio.
- Cablare rispettando la polarità (rosso +, nero -)
- Collegare ad un alimentatore per LED certificato classe III – SELV e con uscita protetta dai corto circuiti e dalle sovracorrenti e con protezione dalle sovratemperature.



GENERAL ASSEMBLY instructions

- Switch off the main switch. Mount the unit following the manual on the back of this sheet.
- Wire with correct polarity (red +, black -)
- Power up by LED power supply certified class III - SELV with output protected from short circuits and overcurrent and with overheating protection.

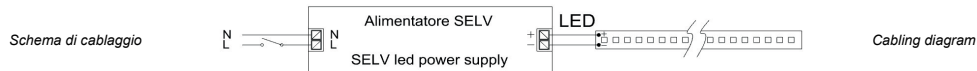

AVVERTENZE di montaggio, uso e manutenzione

L'apparecchio D'ILLUMINAZIONE è sicuro solo se usato all'interno e in ambienti asciutti, privi di liquidi, gas e polveri, non coperto e installato da persona addestrata, nel rispetto della destinazione d'uso e delle norme di manutenzione; non connettere quando è nell'imballo. L'apparecchio non è un giocattolo; i materiali dell'imballo possono essere pericolosi (rischio di soffocamento, ...), non lasciarli a portata dei bambini.



WARNINGS mounting, use and maintenance

The LIGHTING fixture must be used only indoor and installed in dry location, free of liquids, gas and dust, not covered, and installed by qualified technicians and used only for the purpose for which it was designed and in respect of maintenance instructions; do not connect while it is in the packaging. The luminaire is not a toy; packing materials may constitute a hazard (risk of suffocation, abrasion, etc.) and must not be left within reach of children.

Conservare le istruzioni per la manutenzione.

Keep a copy for maintenance.

A fine vita è "Rifiuto di Apparecchio Elettrico e Elettronico" (RAEE). Non gettare nell'indifferenziato. Riciclare è rispettare l'ambiente e la legge (DIR96/02/CEE): informarsi sui punti di raccolta differenziata previsti dalla legge (l'abuso è punibile. Art 50 e seg Dlgs 22/97)



At the end of its life it's "Wast Electrical and Electronic Equipment" (WEEE). Do not throw into the undifferentiated. Environmental and law (DIR 96/02/EEC) respect enquire and recycle in the separate collection (The abuse at EU is punishable).

CE significa "apparecchio conforme a Dir./Reg. 2014/35/UE mod. 2006/95/CE (LVD), 2014/30/UE mod. 2004/108/EC (EMC), 2006/25/EC (Photobiological safety), 2009/125/UE-2010/30/UE-Reg.2012/874-ErP.2012/1194 (Energy Label), 2011/65/UE (RoSH), 2012/19/UE (RAEE), Reg.1907/2006/CE (REACH)



CE means "Apparatus complying with Dir. / Reg. 2014/35/UE mod. 2006/95/CE (LVD), 2014/30/UE mod. 2004/108/EC (EMC), 2006/25/EC (Photobiological safety), 2009/125/UE-2010/30/UE-Reg.2012/874-ErP.2012/1194 (Energy Label), 2011/65/UE (RoSH), 2012/19/UE (RAEE), Reg.1907/2006/CE (REACH)

Far sostituire immediatamente da persona qualificata parti difettose/votve con parti originali, ma solo a freddo e a interruttore aperto \ spina tolta; richiuderlo \ inserire la spina, solo con le lampade inserite e solo se marcate con i Volt e Watt e/o i mA specificati, per evitare surriscaldamento. Per la pulizia utilizzare sempre un panno asciutto e senza utilizzare detergenti abrasivi.



A qualified technician must replace immediately the defective/ broken parts with original parts, but only with cold luminaire and after the opening of the main switch \ plug removed; then close \ insert the plug, only with lamps included. Insert only the lamps marked with the V and W and/or mA specified, to avoid overheating. For cleaning always use a dry cloth and do not use harsh detergents.

Un apparecchio in classe di isolamento III, è sicuro solo con alimentazione in bassissima tensione di sicurezza (SELV), protetto da corto circuito, surriscaldamento e sovracorrenti.



A fixture with Class III insulation rating, is conform to safety rules only if powered at safe low voltage (SELV) Power supply, equipped with short-circuit, overheating and overcurrent protections.

Non collegare direttamente alla rete ma a un alimentatore specifico. "L'installazione può richiedere il coinvolgimento di personale qualificato". Se il cavo flessibile esterno di questo apparecchio è danneggiato, deve essere sostituito esclusivamente dal costruttore, dal suo servizio assistenza o da personale qualificato equivalente al fine di evitare pericoli.



Do not connect directly to the mains but at a specific power supply. "The installation may require the involvement of qualified personnel". If the external flexible cable of this luminaire is damaged, it must be replaced only by the manufacturer, its service or equivalent qualified personnel in order to avoid dangers.

L'apparecchio non funzionante, può essere riparato solo dal fabbricante, dal suo servizio assistenza o da un tecnico qualificato.



The failed luminaire, it can only be repaired by the manufacturer, by his service agent or by a qualified technician.

La sorgente luminosa contenuta in questo apparecchio deve essere sostituita solo dal costruttore o dal suo servizio di assistenza o da personale altrettanto qualificato.



The light source installed in this device must be replaced by the manufacturer or by his assistance service or by equally qualified personnel.

Apparecchio acceso e verificato ai valori nominali:
NON SIAMO RESPONSABILI DI MONTAGGI ERRATI (POLARITÀ,...)



Luminaire turned on and verified to the nominal values:
WE ARE NOT RESPONSIBLE FOR INCORRECT ASSEMBLY (POLARITY,...)



www.designluce.com
info@designluce.com

Design Luce srl
Via Bruno Storti 9/11
50019 Sesto Fiorentino
Firenze - ITALIA

+39 0557223975

CH012
102XXXXXXXX



Montaggio delle testate di chiusura
Deads end mounting

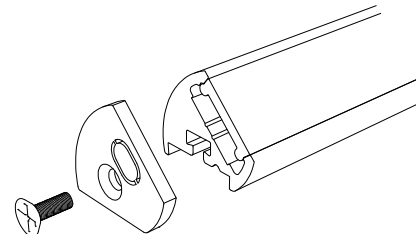

Montaggio del supporto magnetico
Magnet mounting

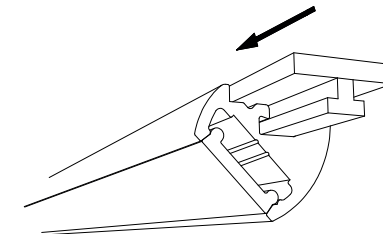

Montaggio in superficie
Surface mounting

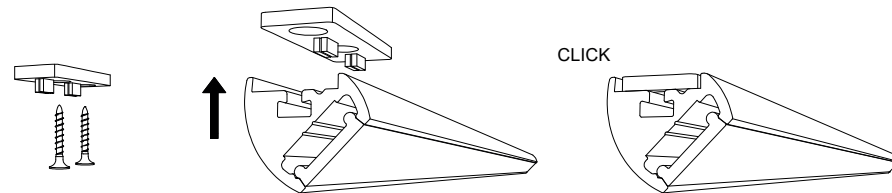

Montaggio del giunto lineare
Straight joint mounting

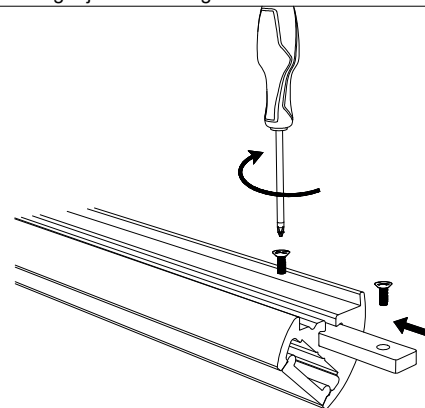

Collegamento elettrico
Wiring

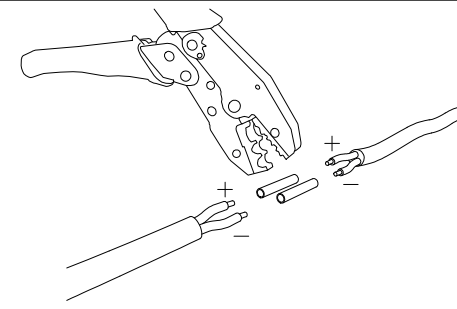

24 V CC da alimentatore SELV remoto
24 V DC from remote SELV power supply



Design Luce srl
Via Bruno Storti 9/11
50019 Sesto Fiorentino
Firenze - ITALIA

www.designluce.com
info@designluce.com

+39 0557223975



ALIMENTATORI e DIMMER
POWER SUPPLIES and DIMMER

Schema collegamento ALIMENTATORI art.:
Wiring diagram led POWER SUPPLY ref.:

980102 - 980502 - 980302
980352 - 980602 - 980752
980962 - 981202 - 981506
982006 - 980306 - 980756
981006 - 981506 - 982006
982406

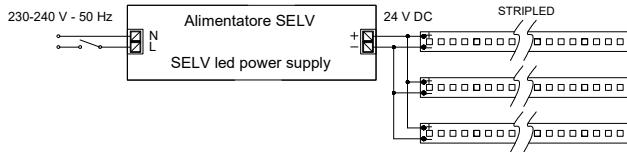

Schema collegamento ALIMENTATORI art.:
Wiring diagram led POWER SUPPLY ref.:

98035D - 98060D
98100D - 98150D

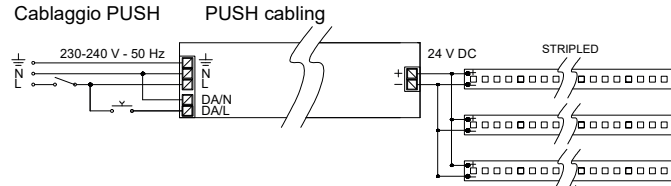
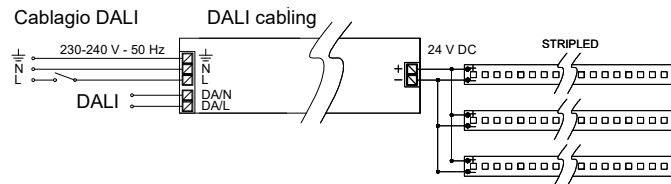

Schema collegamento DIMMER DALI art.:
Wiring diagram DALI DIMMER ref.:

98200D

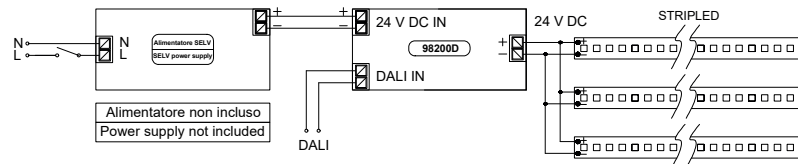

Schema collegamento DIMMER DMX art.:
Wiring diagram DMX DIMMER ref.:

98200M

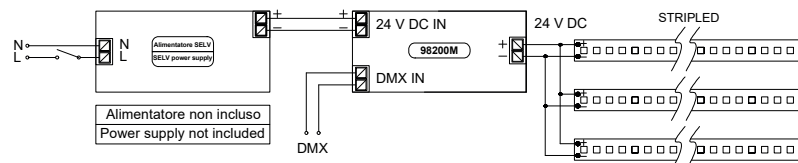

Design Luce srl
Via Bruno Storti 9/11
50019 Sesto Fiorentino
Firenze - ITALIA

www.designluce.com
info@designluce.com

+39 0557223975



ALIMENTATORI e DIMMER
POWER SUPPLIES and DIMMER

Schema collegamento DIMMER 0-10 V art.:
Wiring diagram 0-10 V DIMMER ref.:

98200V

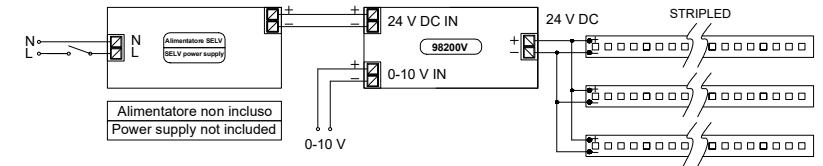

Schema collegamento CONTROLLER RGB + RADIOCOMANDO art.:
Wiring diagram RGB CONTROLLER + REMOTE TOUCH CONTROL ref.:

9924010001

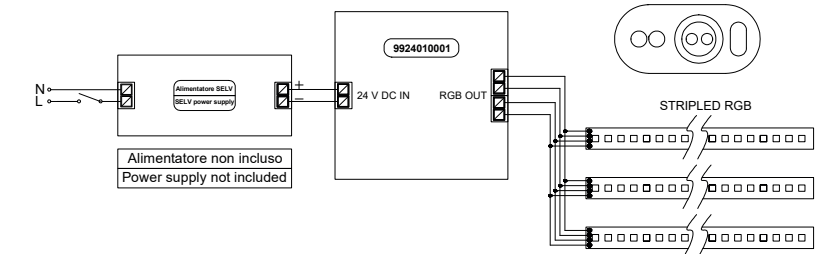

Schema collegamento COMANDO TOUCH RGB a PARETE art.:
Wiring diagram RGB TOUCH PANEL ref.:

9924010002

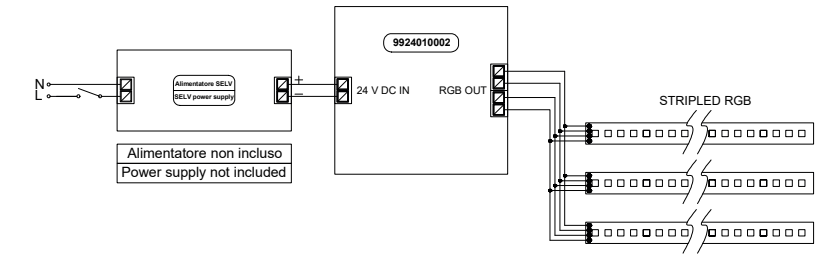

Schema collegamento CONTROLLER RGBW + RADIOCOMANDO art.:
Wiring diagram RGBW CONTROLLER + REMOTE TOUCH CONTROL ref.:

9924010003

