

Schema collegamento ALIMENTATORI art.:
Wiring diagram led POWER SUPPLY ref.:

980102 - 980502 - 980302
980352 - 980602 - 980752
980962 - 981202 - 981506
982006 - 980306 - 980756
981006 - 981506 - 982006
982406

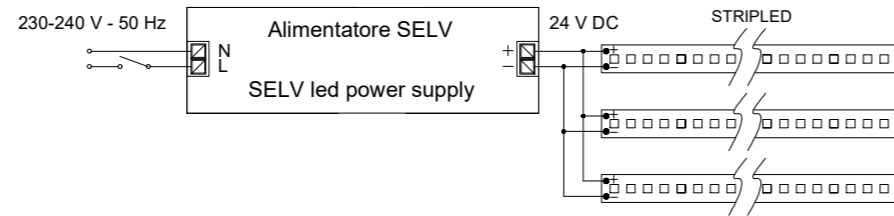

Schema collegamento ALIMENTATORI art.:
Wiring diagram led POWER SUPPLY ref.:

98035D - 98060D
98100D - 98150D

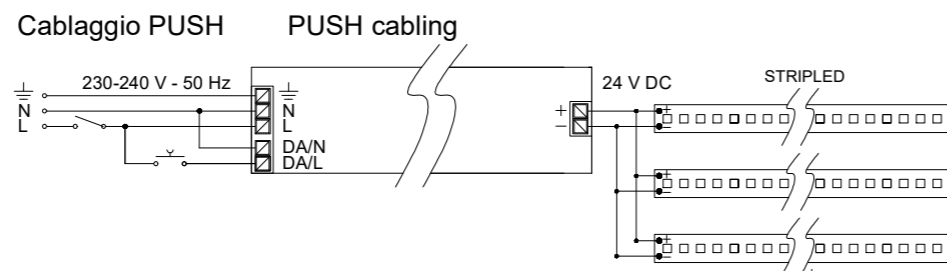
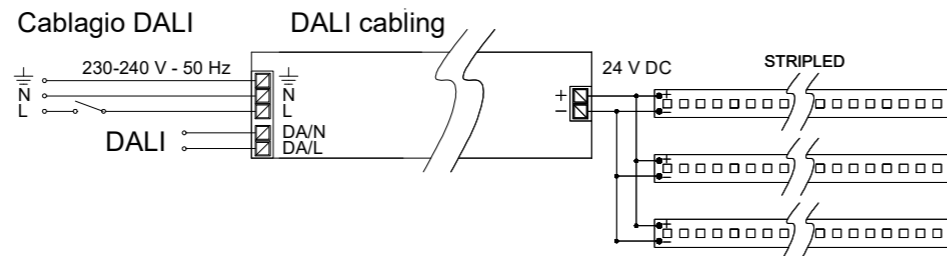

Schema collegamento DIMMER DALI art.:
Wiring diagram DALI DIMMER ref.:

98200D

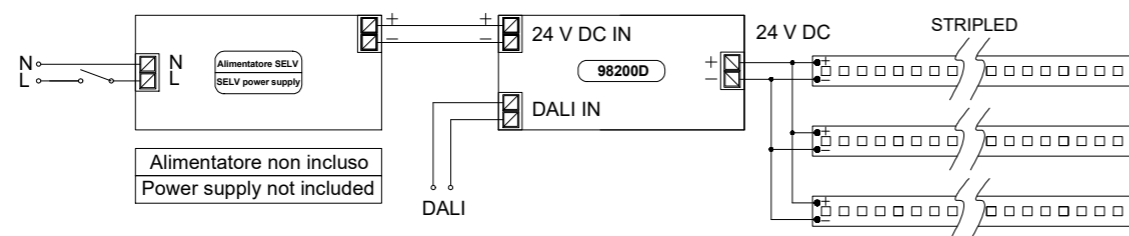

Schema collegamento DIMMER DMX art.:
Wiring diagram DMX DIMMER ref.:

98200M

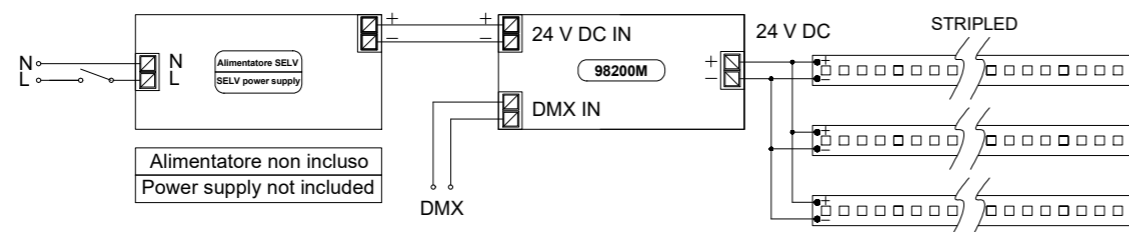

MICHELANGELO

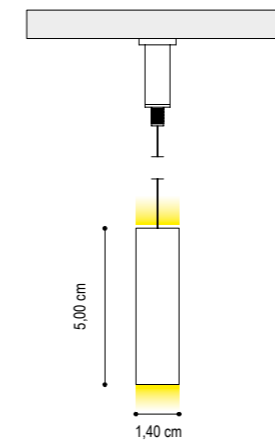

SEZIONE PROFILO/PROFILE SECTION

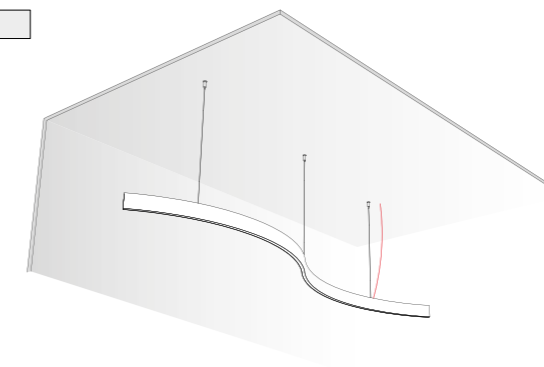

MICHELANGELO CON DRIVER REMOTO
MICHELANGELO WITH REMOTE DRIVER

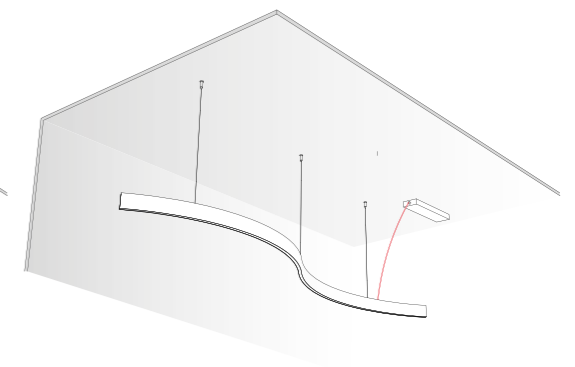

MICHELANGELO CON BOX
MICHELANGELO WITH POWER SUPPLY BOX

INSTALLAZIONE KIT DI SOSPENSIONE
SUSPENSION KIT INSTALLATION

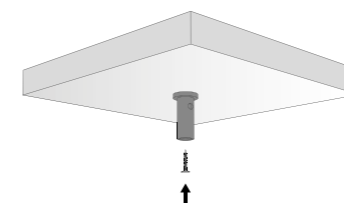

1

1. FISSARE LA BOCCOLA A SOFFITTO PER MEZZO DI TASSELLI IDONEI AL SUPPORTO MURARIO.

1. FIX THE CEILING BUSHING BY MEANS OF SUITABLE DOWELS TO THE WALL SUPPORT.

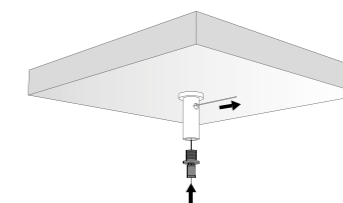

2

2. PREMERE LE DUE ESTREMITÀ DEL PERNO PER INSERIRE IL CAVO IN ACCIAIO FACENDOLO PASSARE NELLA BOCCOLA A SOFFITTO.

2. PRESS THE TWO PARTS OF THE PIN TO INSERT THE STEEL CABLE AND PASS IT INTO THE CEILING BUSHING.

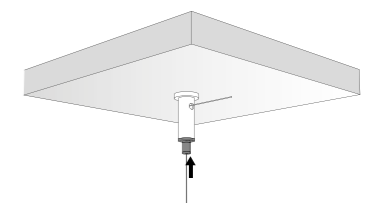

3

3. AVVITARE IL PERNO ALLA BOCCOLA. PREMERE LA PARTE INFERIORE DEL PERNO PER REGOLARE LA LUNGHEZZA DEL CAVO.

3. SCREW THE PIN TO THE BUSH. PRESS THE LOWER PART OF THE PIN TO ADJUST THE CABLE LENGTH.

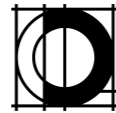

Schema collegamento DIMMER 0-10 V art.:
Wiring diagram 0-10 V DIMMER ref.:

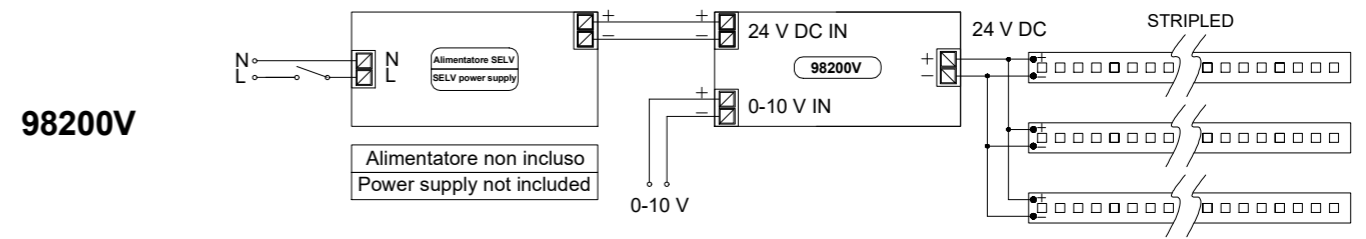

Schema collegamento CONTROLLER RGB + RADIOCOMANDO art.:
Wiring diagram RGB CONTROLLER + REMOTE TOUCH CONTROL ref.:

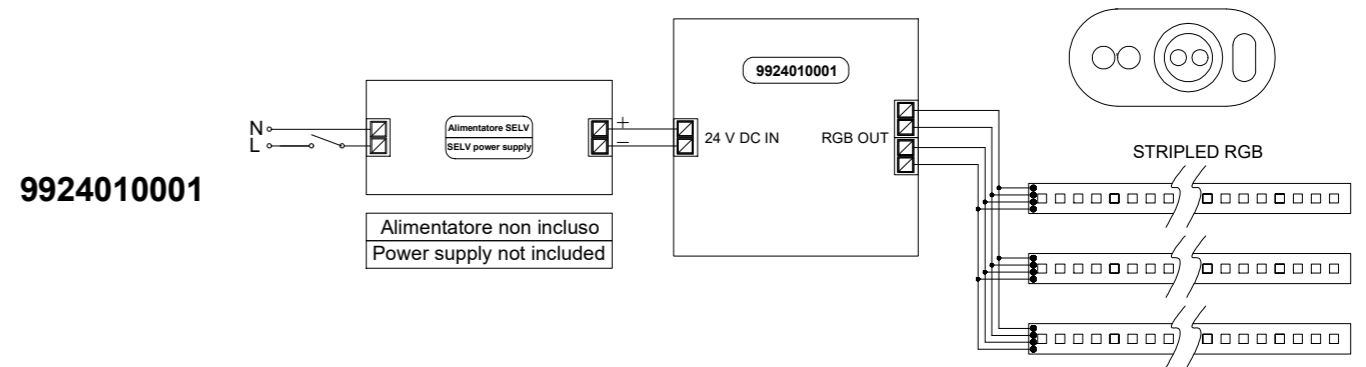

Schema collegamento COMANDO TOUCH RGB a PARETE art.:
Wiring diagram RGB TOUCH PANEL ref.:

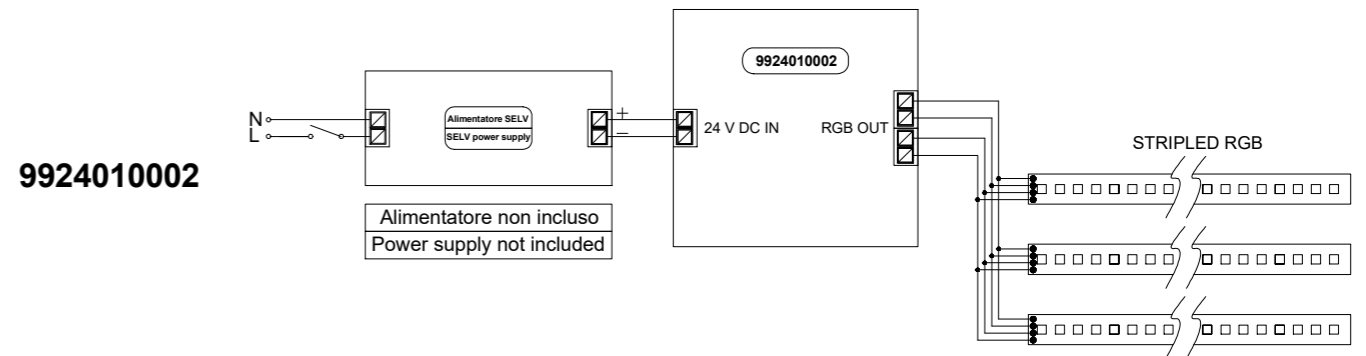

Schema collegamento CONTROLLER RGBW + RADIOCOMANDO art.:
Wiring diagram RGBW CONTROLLER + REMOTE TOUCH CONTROL ref.:

